



Micro D-Sub male 25pin (2x)

part.-no.		part.-name	
T 602 09		SCANIUS two	
file name		OK: date/sign.	
PT60209			
	scale	customers drawing piezosystem jena	
	1:2		

A-A (1 : 2)

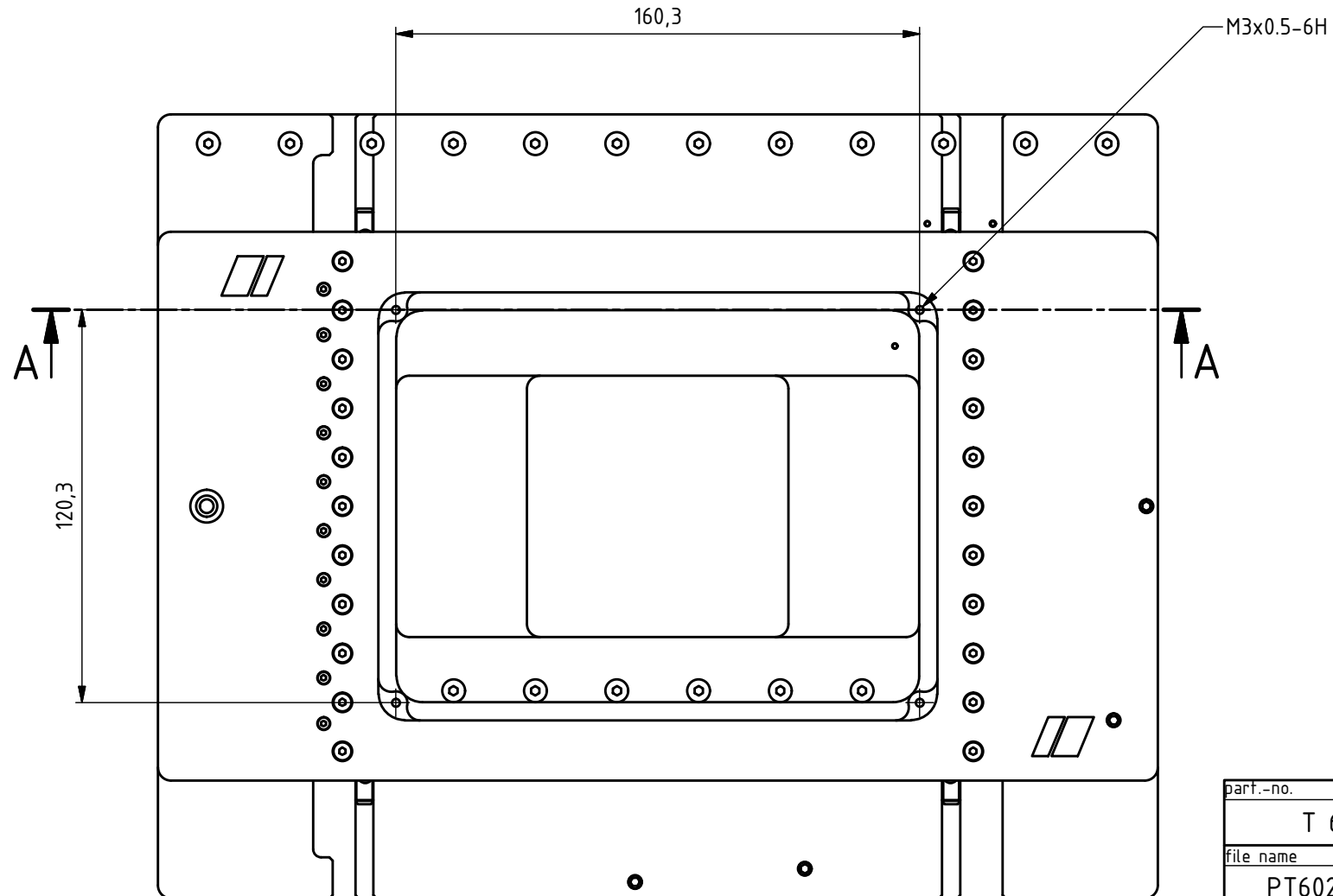
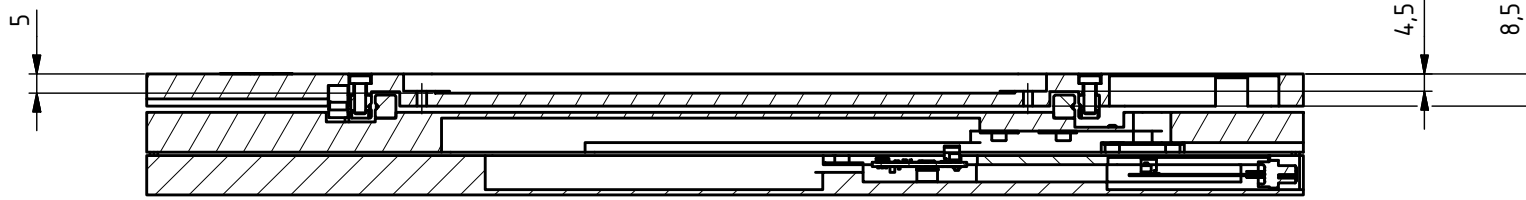

part.-no.		part.-name	
T 602 09		SCANIUS two	
file name		OK: date/sign.	
PT60209			
		scale	customers drawing piezosystem jena
		1:2	

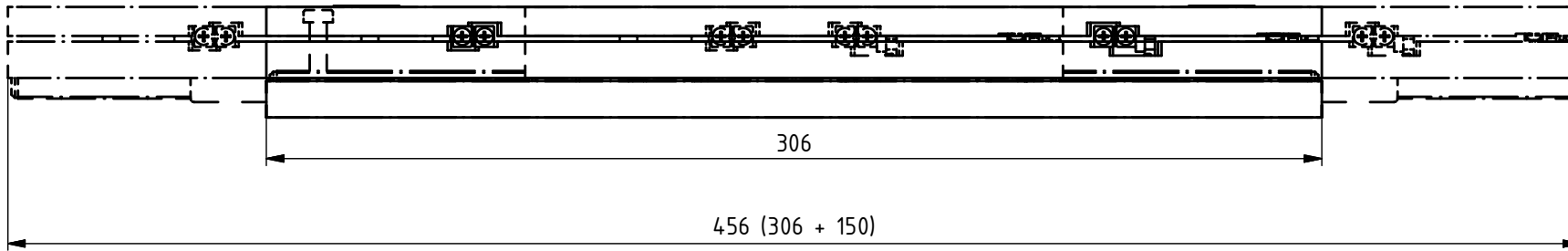

Motion Range
Bewegungsbereich

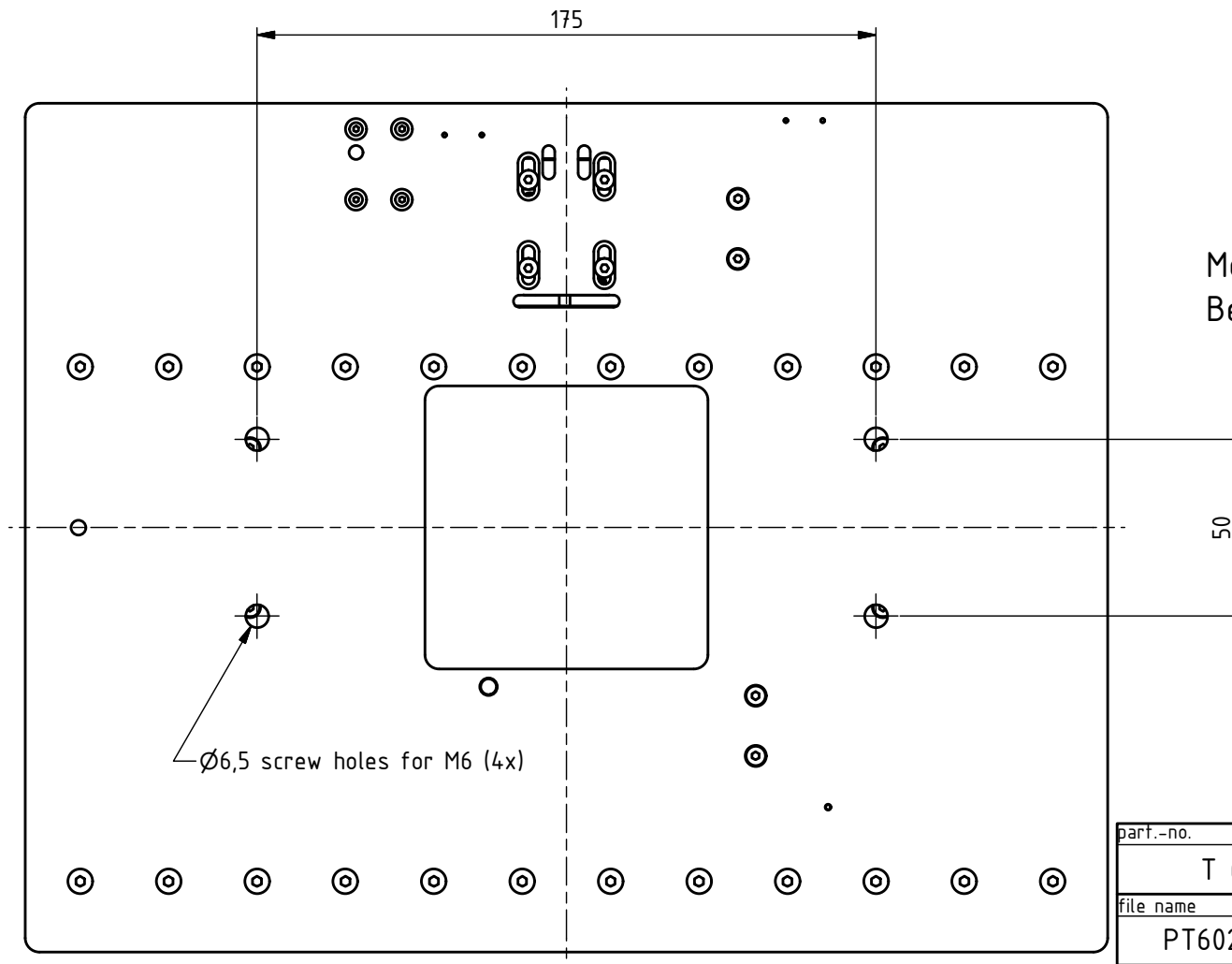

Mounting Grid
Befestigungsraster

part.-no.		part.-name	
T 602 09		SCANIUS two	
file name		OK: date/sign.	
PT60209			
		scale	
		1:2	
customers drawing piezosystem jena			

Scheme of free aperture in end positions

Darstellung des Blickbereiches beim Anfahren der Endlagenpositionen

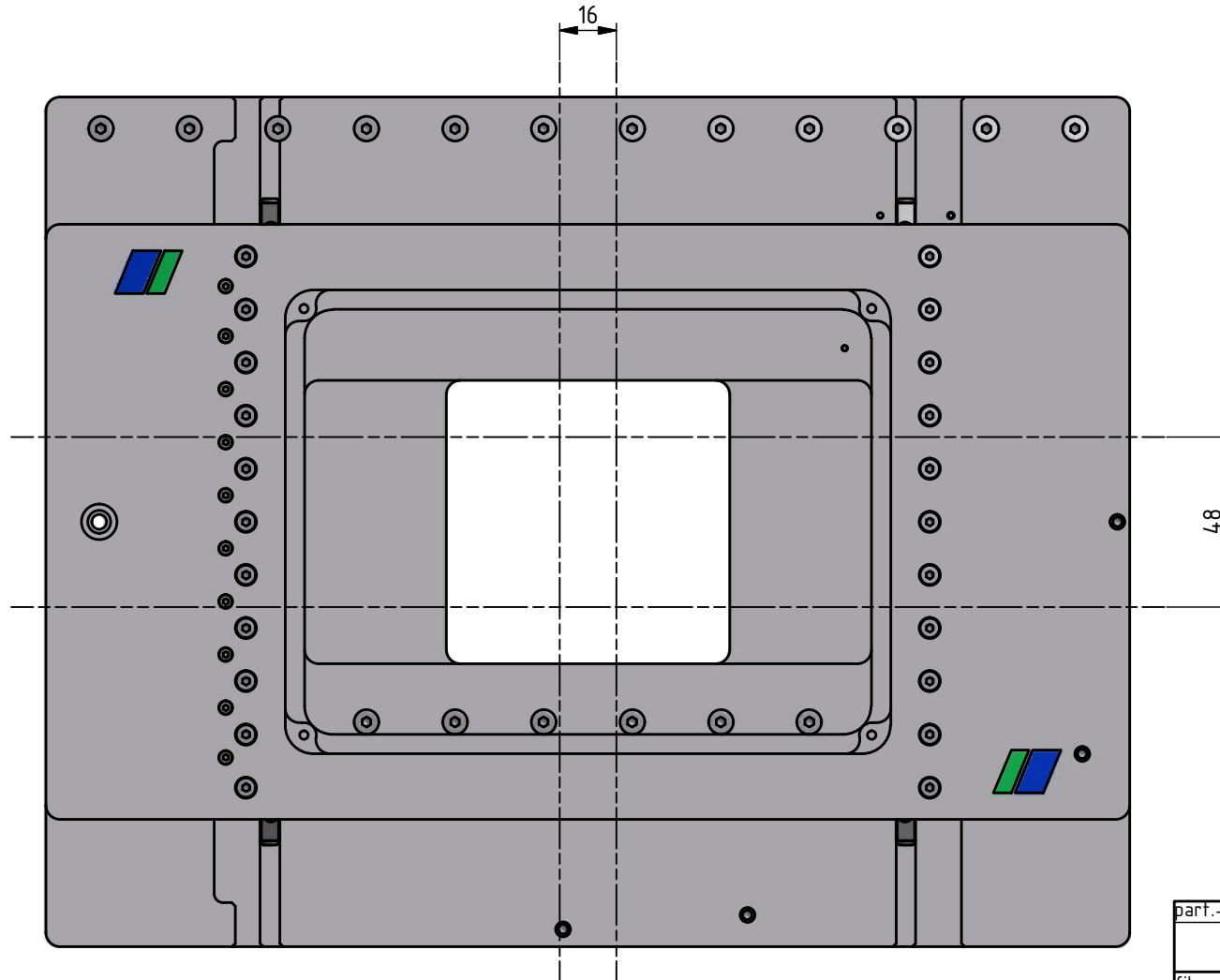

part.-no.	T 602 09	part.-name	SCANIUS two
file name	PT60209	OK: date/sign.	
	scale	customers drawing piezosystem jena	
	1:2		